

SPECIFICATION FOR APPROVAL

REF : 20090602-A

PAGE: 1

PROD.	SHIELDED SMD	ABC'S DWG No.	HP0401□□□□L□-□□□
NAME	POWER INDUCTOR	ABC'S ITEM No.	

I . MECHANICAL DIMENSIONS :

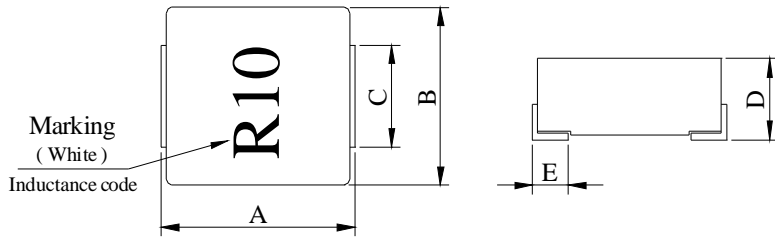

- A : 5.10 ± 0.3 m/m
- B : 4.50 ± 0.2 m/m
- C : 2.00 typ. m/m
- D : 1.20 max. m/m
- E : 1.00 ± 0.3 m/m
- F : 2.30 typ. m/m
- G : 2.20 typ. m/m
- H : 5.00 typ. m/m

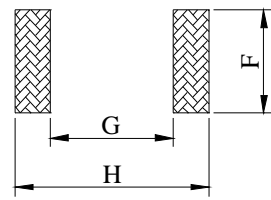

(PCB Pattern)

II . SCHEMATIC DIAGRAM :

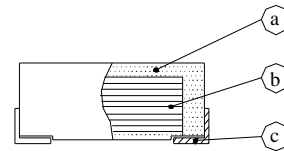
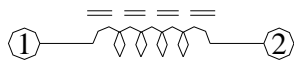

III . MATERIALS LIST :

- a . Core : Iron powder
- b . Wire : Enamelled copper wire
- c . Cilp : Cu / Ni / Sn
- d . Remark : Products comply with RoHS' requirements

IV . GENERAL SPECIFICATION :

- a . Storage temp. : -55°C ~ +125°C
- b . Operating temp. : -55°C ~ +125°C
(Temp. rise included)
- c . Resistance to solder heat : 260°C. 10 secs.

Peak Temp : 260°C max.
 Max time above 230°C : 50sec max.
 Max time above 200°C : 70sec max.

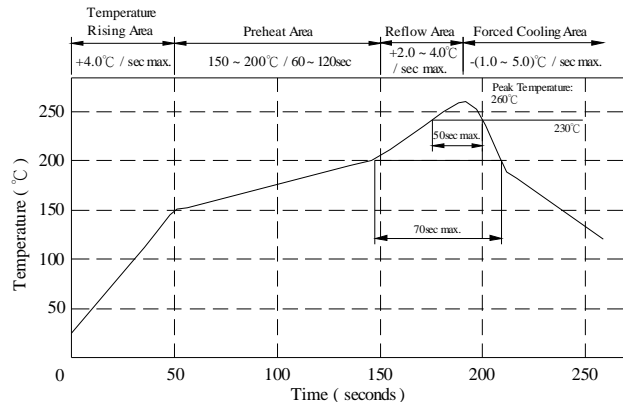

AR-001A

SPECIFICATION FOR APPROVAL

REF : 20090602-A

PAGE: 2

PROD.	SHIELDED SMD	ABC'S DWG No.	HP0401□□□□L□-□□□
NAME	POWER INDUCTOR	ABC'S ITEM No.	

V . ELECTRICAL CHARACTERISTICS :

DWG No.	Inductance L (μ H)	Isat(A) typ.	Irms(A) typ.	RDC ($m\Omega$)	
				max.	typ.
HP040147NML□-□□□	$0.047 \pm 20 \%$	15.0	15.0	3.5	3.0
HP0401R10ML□-□□□	$0.10 \pm 20 \%$	12.0	12.0	5.5	5.0
HP0401R22ML□-□□□	$0.22 \pm 20 \%$	9.5	9.5	10.5	9.5
HP0401R47ML□-□□□	$0.47 \pm 20 \%$	6.0	6.0	21.0	19.0
HP04011R0ML□-□□□	$1.00 \pm 20 \%$	4.5	4.5	47.0	43.0
HP04011R2ML□-□□□	$1.20 \pm 20 \%$	4.0	4.0	55.0	50.0
HP04011R5ML□-□□□	$1.50 \pm 20 \%$	3.5	3.5	75.0	68.0
HP04012R2ML□-□□□	$2.20 \pm 20 \%$	3.0	3.0	100.0	90.0

- 1). □ : Packaging information ... A } Bulk B } Taping Reel
- 2). "- □□□":Reference code
- 3). Measured frequency of inductance is 100 KHz / 0.25V
- 4). Isat base on inductance drop 20% typ. of L value at 20°C
- 5). Irms base on temp. rise 40°C typ.

SPECIFICATION FOR APPROVAL

REF : 20090602-A

PAGE: 3

PROD. NAME	SHIELDED SMD POWER INDUCTOR	ABC'S DWG No.	HP0401□□□□L□-□□□
		ABC'S ITEM No.	

VI . PACKAGING INFORMATION :

(1) Configuration

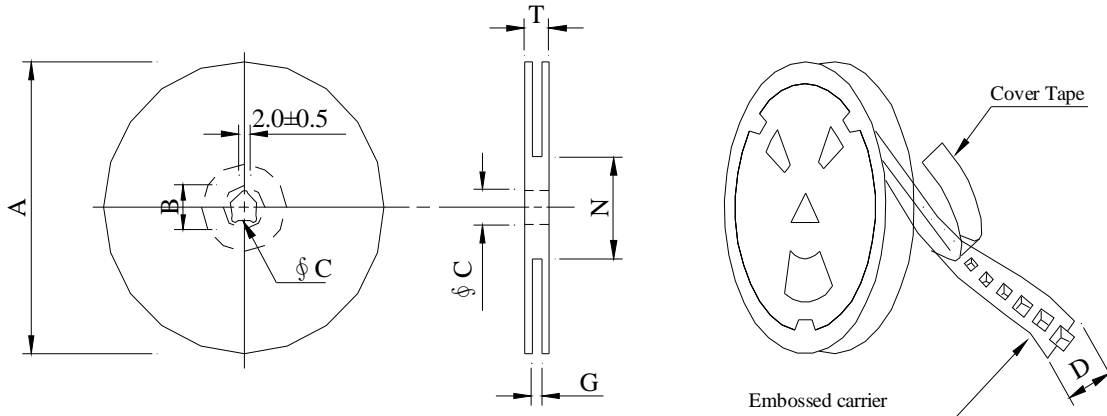

※Carrier tape width : D

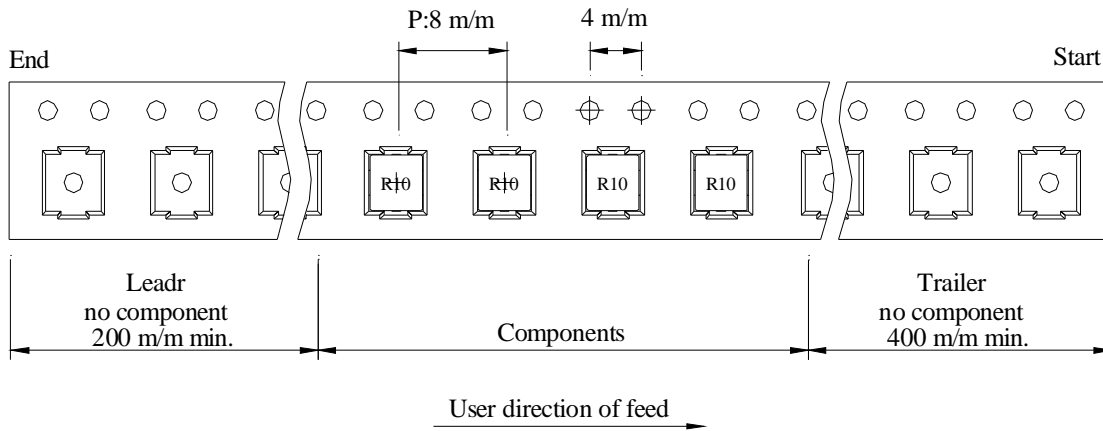

(2) Dimensions

Unit:m/m

Style	A	B	C	D	G	N	T
13 - 12	330	21±0.8	13±0.5	12	14 ⁺⁰	50 ⁻⁰	18.4

(3) Q'TY & G.W. Per package

Series	Inner : Reel			Outer : Carton		
	Q'TY (pcs)	G.W. (gw)	Style	Q'TY (pcs)	G.W. (Kg)	Size (cm)
HP0401	4,800	1,300	13 - 12	38,400	11.00	40 x 40 x 24

AR-001A

SPECIFICATION FOR APPROVAL

REF : 20090602-A

PAGE: 4

PROD. NAME	SHIELDED SMD POWER INDUCTOR	ABC'S DWG No.	HP0401□□□□L□-□□□
		ABC'S ITEM No.	

VII . DWGING NUMBER EXPRESSION :

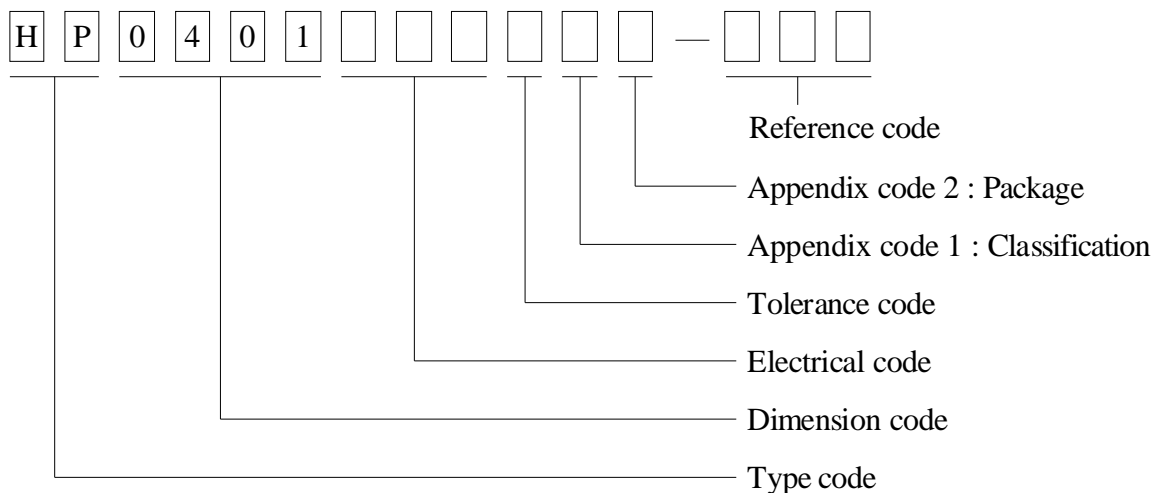

Appendix code 1 : Product Classification

- L : Lead Free Standard products comply with RoHS' requirements
- 1 ~ 9 : Lead Free Special products comply with RoHS' requirements

Appendix code 2 : Package Information

Code	Inner package	Inner package QTY	Remark
A	T.B.D.	T.B.D	
B	T / R (Reel package)	4800 pcs	

SPECIFICATION FOR APPROVAL

REF : 20090602-A

PAGE: 5

PROD. NAME	SHIELDED SMD POWER INDUCTOR	ABC'S DWG No. ABC'S ITEM No.	HP0401□□□□L□-□□□
---------------	--------------------------------	---------------------------------	------------------

VIII . RELIABILITY TEST :

Test item	Specification	Test condition						
Solderability	More than 95% of the terminal electrode shall be covered With fresh solder.	Preconditioning: 150°C/16Hrs±30min Dry Bake Solder : Sn96.5 / Ag3 / Cu0.5 or equivalent Solder temp. :245±5°C Flux : Rosin Dip time: 5±0.5sec						
Thermal shock test (Temp. cycle)	Electrical oharacteristics shall not change more than ±20%	<table style="width: 100%; border: none;"> <tr> <td style="text-align: center;">Room temp. 15 minutes</td> <td style="text-align: center;">→</td> <td style="text-align: center;">-55 °C 30 minutes</td> </tr> <tr> <td style="text-align: center;">Room temp. 15 minutes</td> <td style="text-align: center;">→</td> <td style="text-align: center;">+125 °C 30 minutes</td> </tr> </table> <p>Total : 50 cycles</p>	Room temp. 15 minutes	→	-55 °C 30 minutes	Room temp. 15 minutes	→	+125 °C 30 minutes
Room temp. 15 minutes		→	-55 °C 30 minutes					
Room temp. 15 minutes		→	+125 °C 30 minutes					
Humidity Test		Temperature : 40±2°C Humidity : 90±5% Time : 1000 hours						
High temp. Resistance test	Temperature : 125±5°C Applied current : Per spec. Time : 96 hours							

SPECIFICATION FOR APPROVAL

REF : 20090602-A

PAGE: 6

PROD.	SHIELDED SMD	ABC'S DWG No.	HP0401□□□□L□-□□□
NAME	POWER INDUCTOR	ABC'S ITEM No.	

IX . UL CARD :

OBMW2 September 8, 2000
Magnet Wire-Component

JUNG SHING WIRE CO LTD E174837
231 CHUNG CHENG RD, SEC 3 JEN-TEH HSIANG, TAINAN
HSIEN TAIWAN

Mtl Dsg	Mark Dsg	BC	Coat Typ	OC	ANSI Type	Temp Class
AIW	—	Polyamideimide	—	—	MW81-C	220
CFUEWB	—	Polyurethane	—	—	MW75C	130
EIAIW	—	Polyesterimide	Polyamideimide	—	MW35C	200
EILOCKY	—	Polyesterimide	Polyamide	—	—	180
EILOCKW	—	Polyesterimide	Modified Epoxy	—	—	200
EIW	—	Polyesterimide	—	—	—	220
EIW-2	—	Polyesterimide	—	—	MW74-C	200
FL.EILOCKY	—	Modified Polyester	Polyamide	—	—	155
LSFFW	—	Polyurethane	—	—	MW79-C	155
LSUEW	—	Polyurethane	—	—	—	130
PEW	—	Polyester	—	—	—	155
PEY	—	Polyester	Nylon	—	MW24-C	155
SF.FLW	—	Modified Polyester	—	—	MW26C	155
SF.EIW	—	Polyesterimide	—	—	MW77C	180
SF.BY@	—	Modified Polyester	Nylon	—	MW27-C	155
SF.FLY@	—	Modified Polyester	Nylon	—	MW27-C	155
SF.BLOCKBS	—	Modified Polyester	Modified Polyamide	—	—	155
SF.EILOCKY#	—	Polyesterimide	Polyamide	—	—	180
SF.EILOCKBS	—	Polyesterimide	Modified Polyamide	—	—	180
SF.BW@	—	Modified Polyester	—	—	MW26C	155
SFFW	—	Polyurethane	—	—	MW79	155

A not-for-profit organization dedicated to public safety and committed to quality service

287806002 Page 1 of 2

Mtl Dsg	Mark Dsg	BC	Coat Typ	OC	ANSI Type	Temp Class
SFFY	—	Polyurethane	Polyamide	—	MW80C	155
UEW-1	—	Polyurethane	—	—	MW2-C	105
UEW-2	—	Polyurethane	—	—	—	130
UEW-4	—	Polyurethane	—	—	MW75C	130
UEY	—	Polyurethane	Nylon	—	MW28-C	130
UEY-2	—	Polyurethane	Polyamide	—	MW28-C	130

@-May be suffixed by LZ; # - May be suffixed by LZ, EL or LZL.
LZ - Signifies magened wires twisted together; EL - signifies base coated magnet wire laid parallel with top coat applied overall; LZL - signifies base coated magnet wire twisted together and covered with top coat overall.

Marking: Company name or trademarks or 榮興電線, material designation or marked designation on packaed or reel, and Recognized Component Mark.

See General Information Preceding These Recognitions
For use only in equipment where the acceptability of the combination is determined by Underwriters Laboratories Inc.

287806002 Page 2 of 2 OBMW2/E174837
September 8, 2000

AR-001A

